

First lecture

Environment

The sum total surrounding of a living things which provide conditions for development and growth as well as the dangers and damage .

ICO System

An ECO system includes all of a living things (plants , animals) in given area interacting each other and with non-living things such as(weather, earth ,sun , soil).

ECO system consist of :

1 – Non-living components (organic and in organic) such as carbon , hydrogen and water .

2 – Physical environment : the physical factors which the organism operates .

3 – Living components : divided into

A- Producing creatures : self-feeding organism that manufacture their own food

B- Consumer creature : organism that derive their food from other organism (plants , animals)

C- Analyst creatures : analyze the bodies and remains of the other organism

Pollution

Is the inputting of the pollutants in to the natural environment which harm them and cause turmoil in the ECO system

This pollutants industrial or natural

Types of pollution

1- Chemical pollution

Means the presence of chemical pollutants in the environment (air , water , soil) these pollutants present in a amount higher than natural value .

2 - Biological pollution

Biological pollution arise as a result of presence alive creatures visible or in visible such as bacteria or fungi .

3 – Radioactive pollution

The radioactive pollution means leaking of radioactive material to one of environment components (water , air and soil)

Radioactive pollution consider one of most dangerous types of environmental pollution because we cannot see or smell or feel it .

4 – Noise pollution

5 – Thermal pollution

It is means the thermal change in temperature higher than needing .

6 – Light pollution

It is mean increasing the light

7 – Visual pollution

Atmosphere:-

Known as gaseous layers containing a mixture of gases that surround the earth, the mixture of gases consists mostly of nitrogen 78% then oxygen 21% and the other gases as argon, Co₂ , H₂O vapor, helium , neon and xenon

Main advantages of atmosphere:-

- 1- Providing the necessary air for the living creatures to breathe.
- 2- Protect the earth from harmful radiation, especially U.V.
- 3- Regulate the passages of light.
- 4- Allows the passage of infrared.

Atmosphere layers:-

1- Troposphere :-/

The first layer of the atmosphere and the closest to the earth. It's about 8- 18 Km. which containing 90% of the air mass atmosphere.

2- Stratosphere: -

It is stable layer therefore used by planes in flight. It contains the ozone layer that prevents the harmful radiation from reaching the earth.

3- Mesosphere: -

It is the center of destruction of meteorites.

4- Thermosphere:-

5- Exosphere: -

The last layer in the atmosphere.

Types of radiation in the earth

1- Infrared: - it is invisible, high wave length(low frequency), 49% present

2- Ultra-violet (U.V.)

Low wave length, 7% present harmful

3- Lighting radiation

Environmental engineering

is a professional engineering discipline that takes from broad scientific topics like chemistry, biology, ecology, geology, hydraulics, hydrology, microbiology, and mathematics to create solutions that will protect and also improve the health of living organisms and improve the quality of the environment. Environmental engineering is a sub-discipline of civil engineering , chemical engineering and mechanical engineering.

Environmental engineering is the application of scientific and engineering principles to improve and maintain the environment to:

- *protect human health,
- *protect nature's beneficial ecosystems,
- * improve environmental-related enhancement of the quality of human life.

Environmental engineers devise solutions for wastewater management, water and air pollution control, recycling, waste disposal, and public health. They design municipal water supply and industrial wastewater treatment systems and design plans to prevent waterborne diseases and improve sanitation in urban, rural and recreational areas. They evaluate hazardous-waste management systems to evaluate the severity of such hazards, advise on treatment and containment, and develop regulations to prevent mishaps. They implement environmental engineering law, as in assessing the environmental impact of proposed construction projects.

Applications of environment engineering

- 1- Water supply and treatment
- 2 -Wastewater treatment
- 3 - Air pollution management
- 4 -Water pollution

Second lecture:

Climate change

Climate is sometimes mistaken for weather. But climate is different from weather because it is measured over a long period of time, whereas weather can change from day to day, or from year to year. The climate of an area includes seasonal temperature and rainfall averages, and wind patterns. Different places have different climates. A desert, for example, is referred to as an arid climate because little water falls, as rain or snow, during the year. Other types of climate include tropical climates, which are hot and humid, and temperate climates, which have warm summers and cooler winters.

Climate change is the long-term alteration of temperature and typical weather patterns in a place. Climate change could refer to a particular location or the planet as a whole. Climate change may cause weather patterns to be less predictable. These unexpected weather patterns can make it difficult to maintain and grow crops in regions that rely on farming because expected temperature and rainfall levels can no longer be relied on. Climate change has also been connected with other damaging weather events such as more frequent and more intense hurricanes, floods, downpours, and winter storms.

In polar regions, the warming global temperatures associated with climate change have meant ice sheets and glaciers are melting at an accelerated rate from season to season. This contributes to sea levels rising in different regions of the planet. Together with expanding ocean waters due to rising temperatures, the resulting rise in sea level has begun to damage coastlines as a result of increased flooding and erosion.

The cause of current climate change is largely human activity, like burning fossil fuels, like natural gas, oil, and coal. Burning these materials releases what are called greenhouse gases into Earth's atmosphere. There, these gases trap heat from the sun's rays inside the atmosphere causing Earth's average temperature to rise. This rise in the planet's temperature is called global warming. The warming of the planet impacts local and regional climates. Throughout Earth's history, climate has continually changed. When occurring naturally, this is a slow process that has taken place over hundreds and thousands of years. The human influenced climate change that is happening now is occurring at a much faster rate

greenhouse effect

Our earth surrounded by gaseous cover of mainly N_2 , O_2 and many other gases in small concentration including H_2O vapor and CO_2 . This atmosphere provides the vital O_2 to the living beings, maintain heat balance of the earth and protect us from the harmful radiations. Low wave length radiation coming from sun is reflected back in the form of infrared long wave length radiation, however all of it isn't reflected but part is intercepted by the gases in the earth atmosphere and in turn provides heat on this planet to keep it perpetually warm.

This phenomena termed green-house effect.

These phenomena maintain the average temperature of the world and govern all life processes. The average temperature should remain constant. However it has been noted for the past hundred years that the earth is gradually getting warmer.

Major Green-House gases

- 1- **CO_2** :- the main sources of CO_2 fuel combustion, bio chemical reaction and burning forests
- 2- **CH_4** :- percentage less than CO_2 but more effective. Sources of CH_4 anaerobic decomposition and leaking the natural gases.
- 3- **N_2O** :- main source of N_2O burning forests, analysis compounds which contain N_2 in soil.
- 4- **Water Vapor.**
- 5- **CFC**:- it's organic compounds consist of chloride fluoride and carbon in different rates using in plastic foam industry and in refrigerators; coolers. **CFC** non-flammable, non-toxic very harmful to the ozone layer.
- 6- **Ozone (O_3)** :- increasing the use of **CFC** is causing a depleting in the ozone layer but its concentration increase the lower layer of the atmosphere.

Effect of Green-house Gas builds up.

CO₂ emits and absorbs radiation at wave length typical of the earth and atmosphere. Its concentration increases, the atmosphere offers resistance to the necessary escape of radiation to space since solar radiation is not much effective by the change in the concentration of **CO₂** , surface temperature must rise as a result of the increased resistance.

The other green-house gases act in the same way of **CO₂**

Global warming

Means the increasing in temperature on the earth as a result of increasing green-house gases which prevent the reflection infrared from escaping to the space.

Global warming effect

- 1 - varying effect on agriculture in different areas by decreasing agricultural yield
- 2 – increased pest diseases
- 3 – changes in forest types density and location increasing frequency of the loss to wild life
- 4 – extreme climate prolonged heat waves and droughts
- 5 – heavy rain fall in some areas more droughts in other areas
- 6 – decreasing availability of water and decline in water quality
- 7 – disruption of ecosystem

controlling global warming

- 1 – reduce deforestation and develop way to sustainable agriculture.
- 2 – Use of technologies to absorb **CO₂** to absorb from emission.
- 3 – Increased absorption of **CO₂** by planting more trees.
- 4 – Sequester **CO₂** in the deep ocean.
- 5 – Increased dependence on renewable energy sources.
- 6 – Changed and more environmentally compatible life style.

Ozone layer Depletion

Our earth is surrounded by a layer of ozone about 15-40 Km. above the surface, which keeps about 95% of the sun's harmful UV radiation from reaching the earth's surface. Short wave length UV radiation are absorbed by molecular oxygen which splits up into constituent atoms. These atoms combine with molecular oxygen to produce ozone.



Another photochemical reaction which breaks down ozone molecules due to absorption



These two reactions balance each other and ultimately result in effective absorption of short wavelength UV radiation in the stratosphere region.

Causes of ozone Depletion:-

1- Use of chlorofluorocarbon: As explained above **CFCS** are responsible for maximum damage to ozone layer.

2- Nitrogenous fertilizer: Microbial action on nitrogenous fertilizers produces nitrous oxide.

3- Supersonic transport, rockets and space shuttle:

Supersonic jetliners discharge various oxides of **N₂**, **C**, **S** hydrocarbons and particulate material.

4- Nuclear test: Nuclear explosions release high quantity of various gases and other materials which damage the ozone layer.

Third Lecture

Acid rain

Acid rain refers to the presence of strong mineral acids like sulphuric acid, nitric acid and in some locations HCL , HF which bring down PH in the atmosphere .

The problem of acid deposition is primarily related to the use of high sulphur coal and oil , the combustion of which produce considerable quantities of So₂ , No_x .

The gases react with atmospheric moisture to form H₂SO₄ and HNO₃ .

Effects of acid rain

*** Surface waters and aquatic animals**

Both the lower pH and higher aluminum concentrations in surface water that occur as a result of acid rain can cause damage to fish and other aquatic animals. At pH lower than 5 most fish eggs will not hatch and lower pH can kill adult fish. As lakes and rivers become more acidic biodiversity is reduced. Acid rain has eliminated insect life and some fish species, including the brook trout in some lakes, streams, and creeks in geographically sensitive areas, such as the Adirondack Mountains of the United States. However, the extent to which acid rain contributes directly or indirectly via runoff from the catchment to lake and river acidity (i.e., depending on characteristics of the surrounding watershed) is variable. The United States Environmental Protection Agency's (EPA) website states: "Of the lakes and streams surveyed, acid rain caused acidity in 75% of the acidic lakes and about 50% of the acidic streams Lakes hosted by silicate basement rocks are more acidic than lakes within limestone or other basement rocks with a carbonate composition (i.e. marble) due to buffering effects by carbonate minerals, even with the same amount of acid rain.

*** Soils**

Soil biology and chemistry can be seriously damaged by acid rain. Some microbes are unable to tolerate changes to low pH and are killed. The enzymes of these microbes are denatured (changed in shape so they no longer function) by the acid. The hydronium ions of acid rain also mobilize toxins, such as aluminum, and leach away essential nutrients and minerals such as magnesium

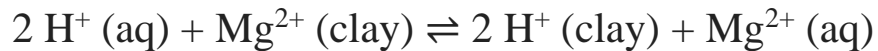

Soil chemistry can be dramatically changed when base cations, such as calcium and magnesium, are leached by acid rain thereby affecting sensitive species, such as sugar maple).

***Forests and other vegetation**

Acid rain can have severe effects on vegetation. A forest in the Black Triangle in Europe.

Adverse effects may be indirectly related to acid rain, like the acid's effects on soil (see above) or high concentration of gaseous precursors to acid rain. High altitude forests are especially vulnerable as they are often surrounded by clouds and fog which are more acidic than rain.

Other plants can also be damaged by acid rain, but the effect on food crops is minimized by the application of lime and fertilizers to replace lost nutrients. In cultivated areas, limestone may also be added to increase the ability of the soil to keep the pH stable, but this tactic is largely unusable in the case of wilderness lands. When calcium is leached from the needles of red spruce, these trees become less cold tolerant and exhibit winter injury and even death.

***Ocean acidification**

Acid rain has a much less harmful effect on the oceans. Acid rain can cause the ocean's pH to fall, making it more difficult for different coastal species to create their exoskeletons that they need to survive. These coastal species link together as part of the ocean's food chain and without them being a source for other marine life to feed off of more marine life will die.

Coral's limestone skeletal is sensitive to pH drop, because the calcium carbonate, core component of the limestone dissolves in acidic (low pH) solutions.

***Human health effects**

Acid rain does not directly affect human health. The acid in the rainwater is too dilute to have direct adverse effects. The particulates responsible for acid rain (sulfur dioxide and nitrogen oxides) do have an adverse effect. Increased amounts of fine particulate matter in the air contribute to heart and lung problems including asthma and bronchitis.

***Other adverse effects**

Acid rain can damage buildings, historic monuments, and statues, especially those made of rocks, such as limestone and marble, that contain large amounts of calcium carbonate. Acids in the rain react with the calcium compounds in the stones to create gypsum, which then flakes off.



The effects of this are commonly seen on old gravestones, where acid rain can cause the inscriptions to become completely illegible. Acid rain also increases the corrosion rate of metals, in particular iron, steel, copper and bronze

Mechanisms of Acid formation in atmosphere:-

H₂SO₄ in air formed from SO₂ in a number of ways depending upon the level of air pollution and environmental conditions of lights and humidity.



HNO₃ can be formed by direct oxidation and catalytic oxidation.



Control Strategies For Acid Rain:

- 1- The use low Sulphur coal or substitution of coal by other fuels.
- 2- Alternative methods for power generation instead of thermal power plants such as hydropower facilities or nuclear power.
- 3- Installation of flue-gas desulphurization system in large power plants can reduce emission of SO_2 .
- 4- Use different new technology like Electron Beam Technology, which converts SO_2 and NO_x into ammonium sulphate [$(\text{NH}_4)_2\text{SO}_4$] and ammonium nitrate [NH_4NO_3] .

The process involved in the reaction of ammonia which is injected from outside into the flue-gas with SO_2 NO_x in a process vessel under the influence of Electrons produced by Electron Beam Gun, it is a possible to remove 95% of SO_2 and 80% of NO_x at the same time from the flue-gas under normal operating conditions by this process

Fourth Lecture:

Air Pollution

Air pollution is a mixture of solid particles and gases in the air. Car emissions, chemicals from factories, dust, pollen and mold spores may be suspended as particles. Ozone, a gas, is a major part of air pollution in cities. When ozone forms air pollution, it's also called smog.

Some air pollutants are poisonous. Inhaling them can increase the chance you'll have health problems. People with heart or lung disease, older adults and children are at greater risk from air pollution. Air pollution isn't just outside - the air inside buildings can also be polluted and affect your health

Types of Pollutants

In order to understand the causes of Air pollution, several divisions can be made.

Primarily air pollutants can be caused by primary sources or secondary sources. The pollutants that are a direct result of the process can be called primary pollutants. A classic example of a primary pollutant would be the sulfur-dioxide emitted from factories

Secondary pollutants are the ones that are caused by the intermingling and reactions of primary pollutants. Smog created by the interactions of several primary pollutants is known to be as a secondary pollutant.

. Various Causes of Air pollution

1. The burning of fossil fuels

Sulfur dioxide emitted from the combustion of fossil fuels like coal, petroleum and other factory combustibles are one the major cause of air pollution. Pollution emitting from vehicles including trucks, jeeps, cars, trains, airplanes cause an

immense amount of pollution. We rely on them to fulfill our daily basic needs of transportation.

But, their overuse is killing our environment as dangerous gases are polluting the environment. Carbon Monoxide caused by improper or incomplete combustion and generally emitted from vehicles is another major pollutant along with Nitrogen Oxides, that is produced from both natural and man-made processes.

2. Agricultural activities

Ammonia is a very common byproduct from agriculture-related activities and is one of the most hazardous gases in the atmosphere. Use of insecticides, pesticides, and fertilizers in agricultural activities has grown quite a lot. They emit harmful chemicals into the air and can also cause water pollution.

3. Exhaust from factories and industries

Manufacturing industries release a large amount of carbon monoxide, hydrocarbons, organic compounds, and chemicals into the air thereby depleting the quality of air. Manufacturing industries can be found at every corner of the earth and there is no area that has not been affected by it. Petroleum refineries also release hydrocarbons and various other chemicals that pollute the air and also cause land pollution.

4. Mining operations

Mining is a process wherein minerals below the earth are extracted using large equipment. During the process dust and chemicals are released in the air causing massive air pollution. This is one of the reasons which is responsible for the deteriorating health conditions of workers and nearby residents.

5. Indoor air pollution

Household cleaning products, painting supplies emit toxic chemicals in the air and cause air pollution. Have you ever noticed that once you paint the walls of your house, it creates some sort of smell which makes it literally impossible for you to breathe?

Suspended particulate matter popular by its acronym SPM, is another cause of pollution. Referring to the particles afloat in the air, SPM is usually caused by dust, combustion, etc

Definitions of terms that describe airborne particulate

- 1- Particulate matter:- any material except uncombined water that exist in the solid or liquid state.
- 2- Aerosols:- A dispersion of microscopic solid or liquid particulate in gaseous media.
- 3- Dust:- Solid particles larger than colloidal size capable of temporary suspend.
- 4- Fly ash:- particles of ash entrained in flue gas. Particles may contain unburned fuel.
- 5- Fog:- Visible aerosol.
- 6- Fume:- Particles formed by condensation, sublimation or chemical reaction.
- 7- Mist:- Dispersion of small liquid droplets of sufficient size to fall from the air.
- 8- Smoke:- small gas borne particles resulting from combustion .
- 9- Soot:- An agglomeration of carbon particles.

Particulate Control Equipment

A number of factors must be determined before a proper choice of collection equipment can be made:

- 1- Physical and chemical properties of the particulate.
- 2- The range of the volumetric flow rate of the gas stream.
- 3- The range of expected particulate concentration. (dust loading)
- 4- The temperature and pressure of flow stream.
- 5- The collection efficiency that required for outlet gas stream.

Dry type Collectors:-

1- Gravitational settling chambers:-

Gravitational settling chambers are simple, inexpensive collectors; the gas velocity slowed down to allow settling of dust and mist particulate by the force of gravity.

This device is suitable for particles above $50 \mu\text{m}$ the gas in the settling chamber which is related to velocity of the gas flow and the chamber volume.

The pressure drop is small and it is usually used as primary device for removal of coarse particles

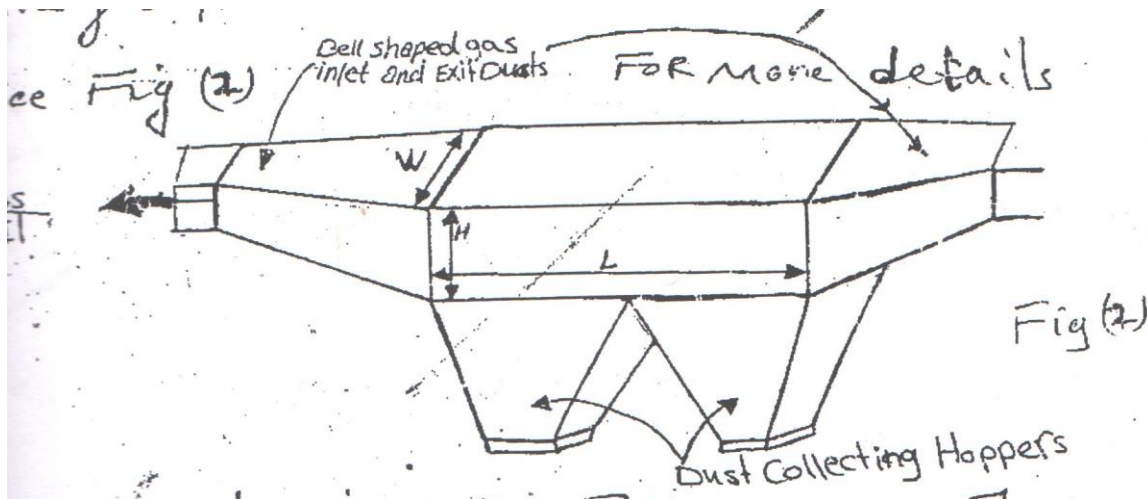

2- Centrifugal Separators:- (Cyclones)

Cyclones are the principle type of gas solid separator employing centrifugal force.

Cyclones are suitable for separating particles above 5 μm diameter, smaller particles; down to about 0.5 μm can be separated where agglomeration occurs.

The most commonly used design is the reverse-flow cyclone the gas enters the top chamber tangentially and spirals down to the apex of the conical section, it then moves upward then exits moves radially to the walls and are collected at the bottom.

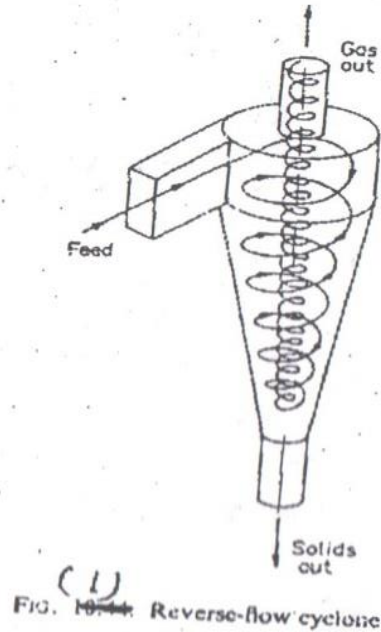

Types of Cyclones:-

1- Volume cyclone:- diameter are generally larger efficiencies moderate to lower, and they can handle larger flow rates. Particles greater than 50 μm are collected with great efficiency.

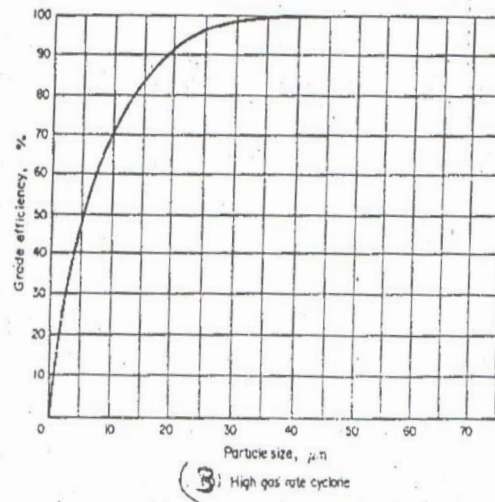
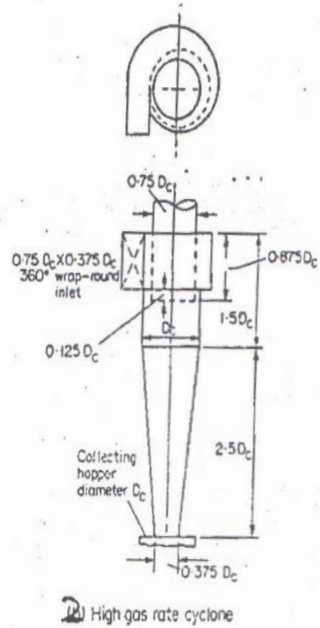

2- High efficiency cyclones:- The inlet gas velocity is higher, thereby importing a higher centrifugal force. It removes particles up to 5 μm they are generally less than 1 ft in diameter.

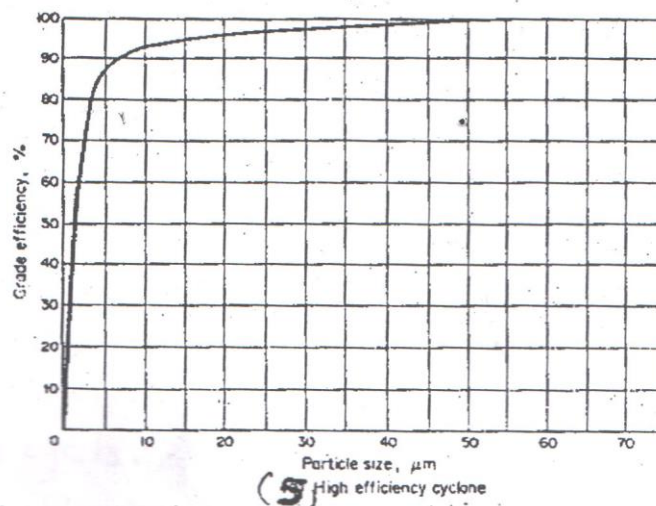
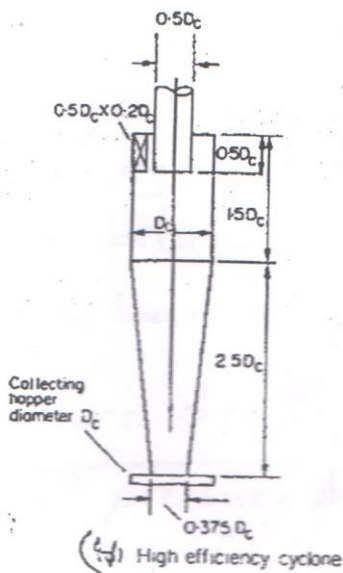

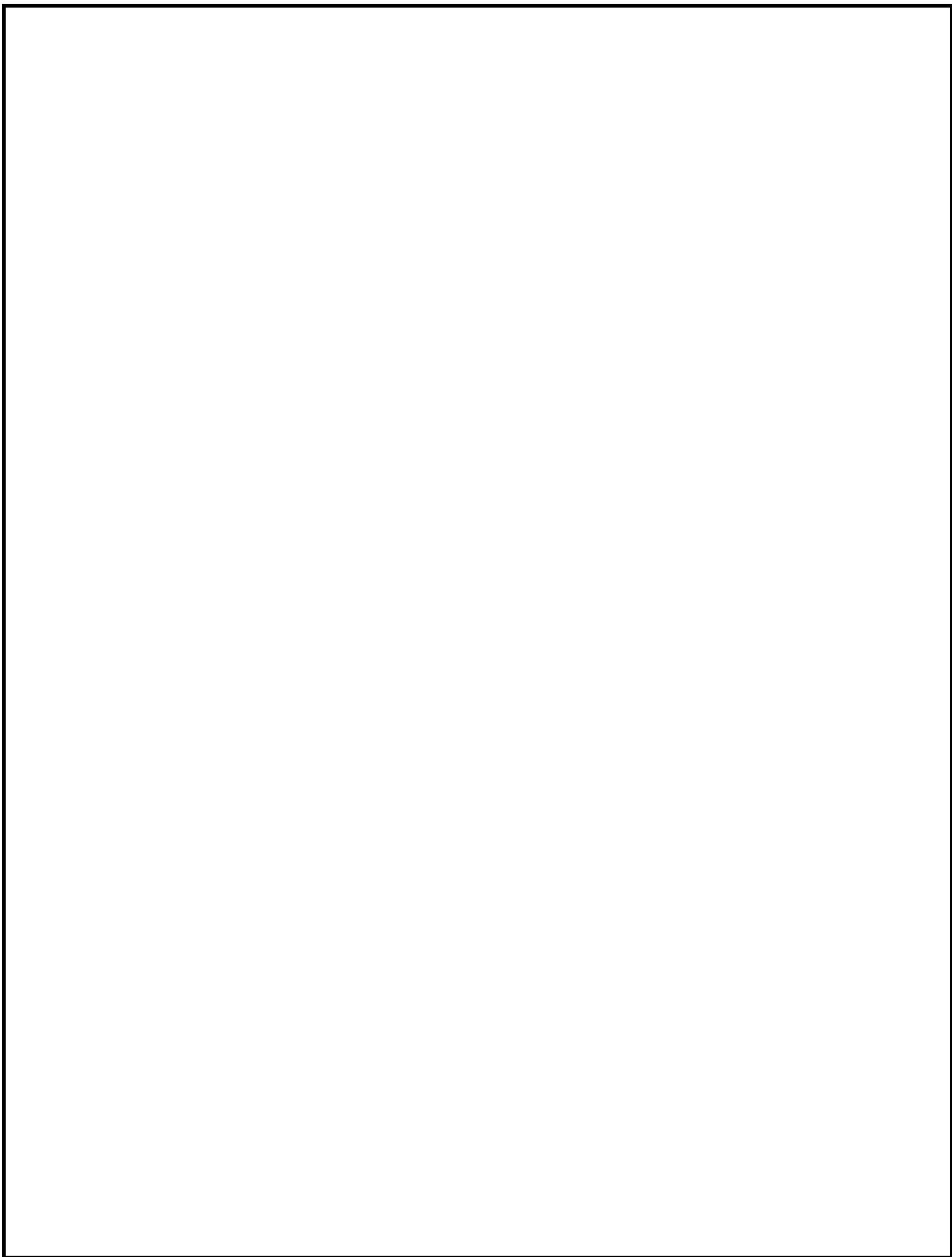

Fifth Lecture

Wet Collection (scrubbers)

removed in suitably designed In wet scrubbing the dust is removed by counter current washing with liquid usually water, the solid are removed as slurry.

The principal mechanism involved impact (impingement) of the dust particles and water droplet. Particle sizes down to 0.5 μm can be scrubbers.

In addition to removing solids, wet scrubbers can be used to simultaneously cool the gas and neutralize any corrosive constituent.

Droplet production

Droplets are produced by several methods:

1. Injecting liquid at high pressure through specially designed nozzles
2. Aspirating the particle-laden gas stream through a liquid pool
3. Submerging a whirling rotor in a liquid pool.

These droplets collect particles by using one or more of several collection mechanisms such as impaction, direct interception, diffusion, electrostatic attraction, condensation, centrifugal force and gravity. However, impaction and diffusion are the main ones.

The advantages of scrubbers:-

- 1- Can be used to remove materials in size range of 0.2-10 μm
- 2- Can remove simultaneously particulate and gases.
- 3- It has high efficiency for small particles.
- 4- There is no particle re-entrainment

The disadvantages of scrubbers:-

- 1- Handling of dirty liquid and removal of the entrained material is difficult.
- 2- It may cause water pollution and there is a need to treatment method to remove particles from the liquid.
- 3- Do not function well where plume rise is important, since a wet plume has a little buoyancy.

Types of Wet Collection (scrubbers)

1- Spray tower:-

its simplest form. The spray tower consists of a downward flow of water. Droplet sprayed into the tower and an upward flow of dirty gas.

High pressure sprays produce small drops with more surface area per mass of water used and there are effective in collecting particles in the range of $5\ \mu\text{m}$ with efficiency of 99%.

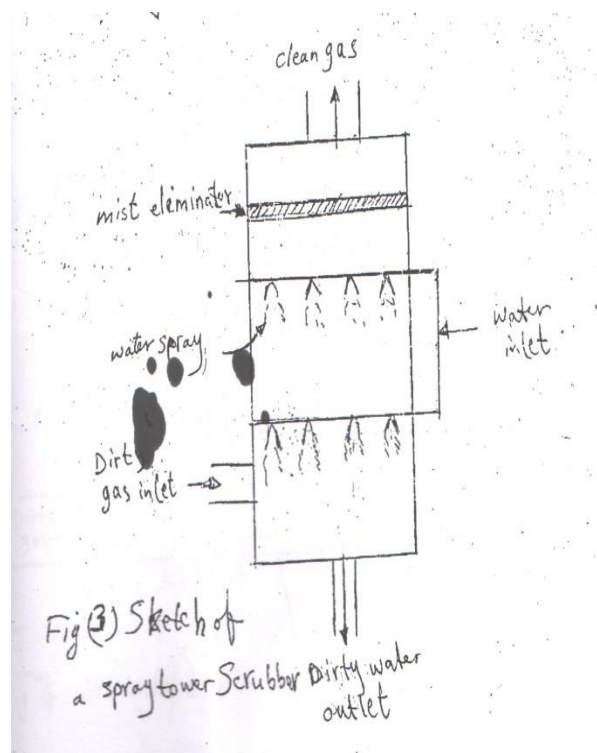

2 - Cyclone scrubber:-

The gas is tangentially swirled around just as the dry cyclone. Water sprays are introduced in variety of ways either a cross the cyclone from the outside wall to the center line or down the cyclone from the top. The compound impingement and center centrifugal forces clean the gas.

Collection efficiency 90-98% for particulate range $50\ \mu\text{m}$ to $5\ \mu\text{m}$.

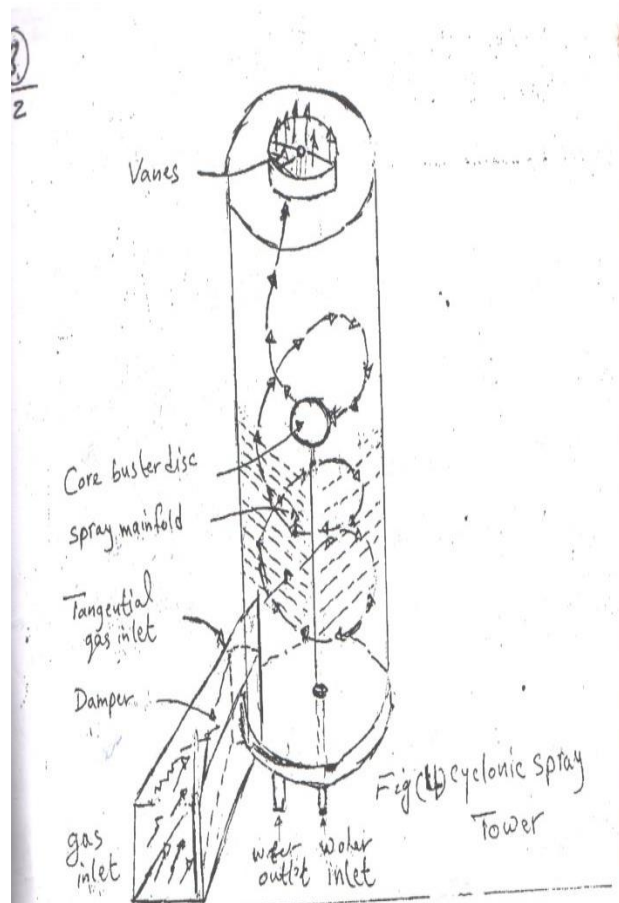

3 - Venturi Scrubber:-

Venturi is a rectangular or circular flow channel which converges to narrow throat section and then diverges back to its original cross sectional area then narrowing causes the acceleration of the velocity of the gases to a high level in the venturi section. Water sprayed into venturi section which atomized by the high velocity gas.

Venturi scrubber 100% efficient in removing particles larger than 5 μm .

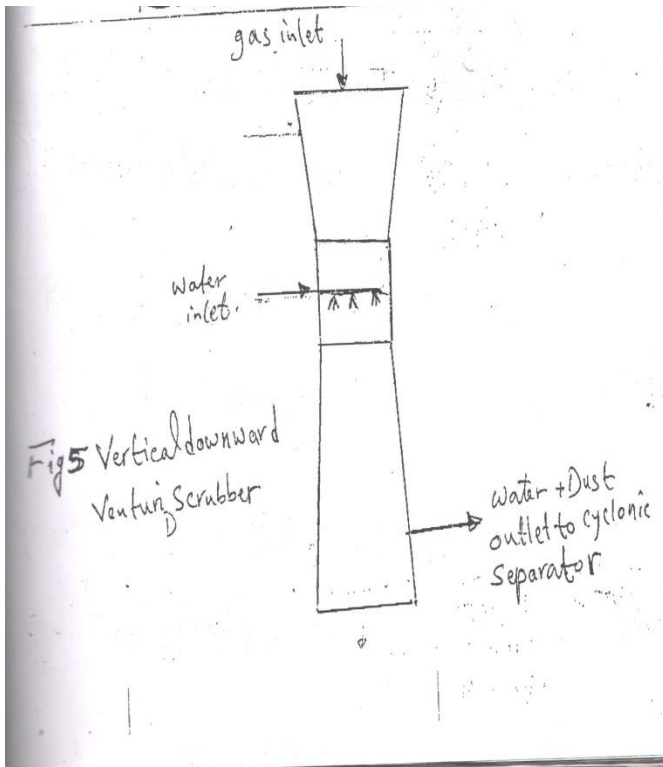

Fig 5 Vertical downward Venturi Scrubber

Sixth Lecture

Fabric Filters:-

The dirty gases are passed through woven or filtered fabrics so as to retain the particles and allowing clean gas to pass out.

The filter systems are consisted of several thin, long bags hanging in enclosure, called a baghouse. The air in a baghouse flows through the open ends of the bags and passes out from their sides to be finally released out of the filter system as a clean gas.

* A baghouse, also known as a baghouse filter, bag filter, or fabric filter is an air pollution control device and dust collector that removes particulates or gas released from commercial processes out of the air.[2] Power plants, steel mills, pharmaceutical producers, food manufacturers, chemical producers and other industrial companies often use baghouses to control emission of air pollutants

The fabric filter layers

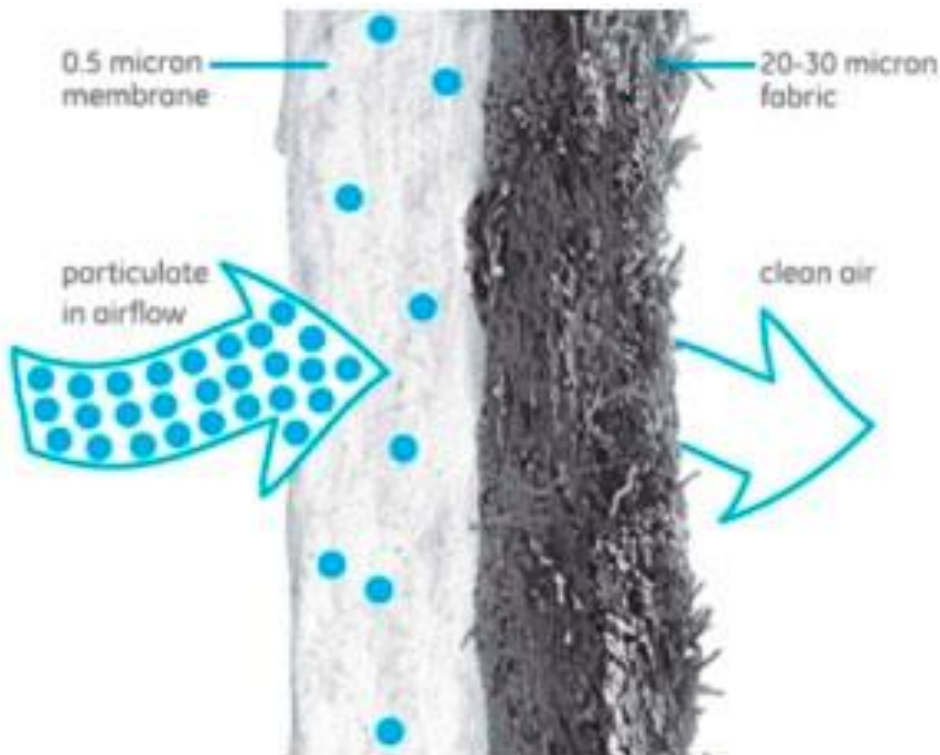

Advantages of Fabric Filter are:-

- 1- High collection efficiency over a broad range of particle sizes.
- 2- Volumetric capacities in a single installation.
- 3- Reasonable operating pressure drops and power requirements.
- 4- Ability to handle a diversity of solid material.

Disadvantages of Fabric Filter are:-

- 1- Clogging of filters.
- 2- Space factors may be prohibiting consideration.
- 3- Possibility of explosion.
- 4- Hygroscopic material can't be handling.

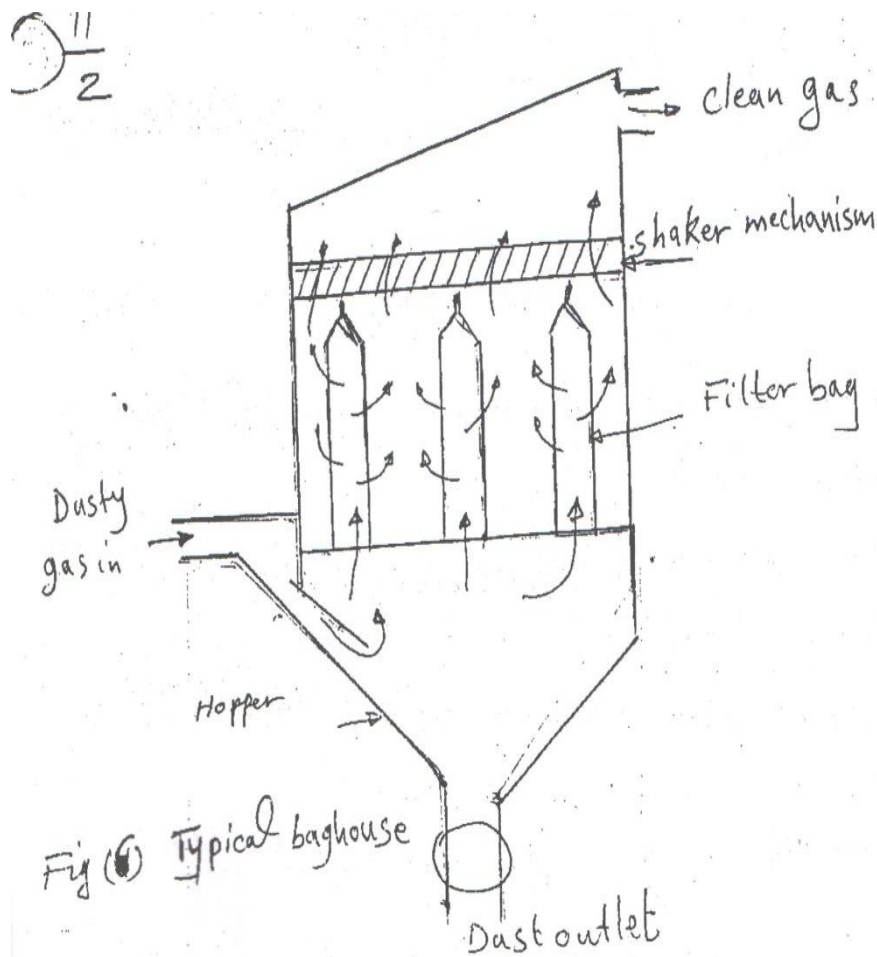

Electrostatic Precipitators (EPA)

The voltage difference between the electrode and the collector plates is maintained at as high a level as possible but below the field strength at which spark-over occurs. Electrons are released at the electrode in a corona discharge and attach themselves to particles, thus charging particles. The charge particles or molecules (ions) of the same polarity as the electrode migrate toward the ground surface due to electrostatic forces.

Advantage of EPA:

- 1- Handle large volume of gases from which aerosol must be removed.
- 2- capable of collecting very fine particles.
- 3- Low pressure drop.
- 4- Relatively easy removal of the collected particulate

Disadvantage of EPA

The capital and operating costs are high.

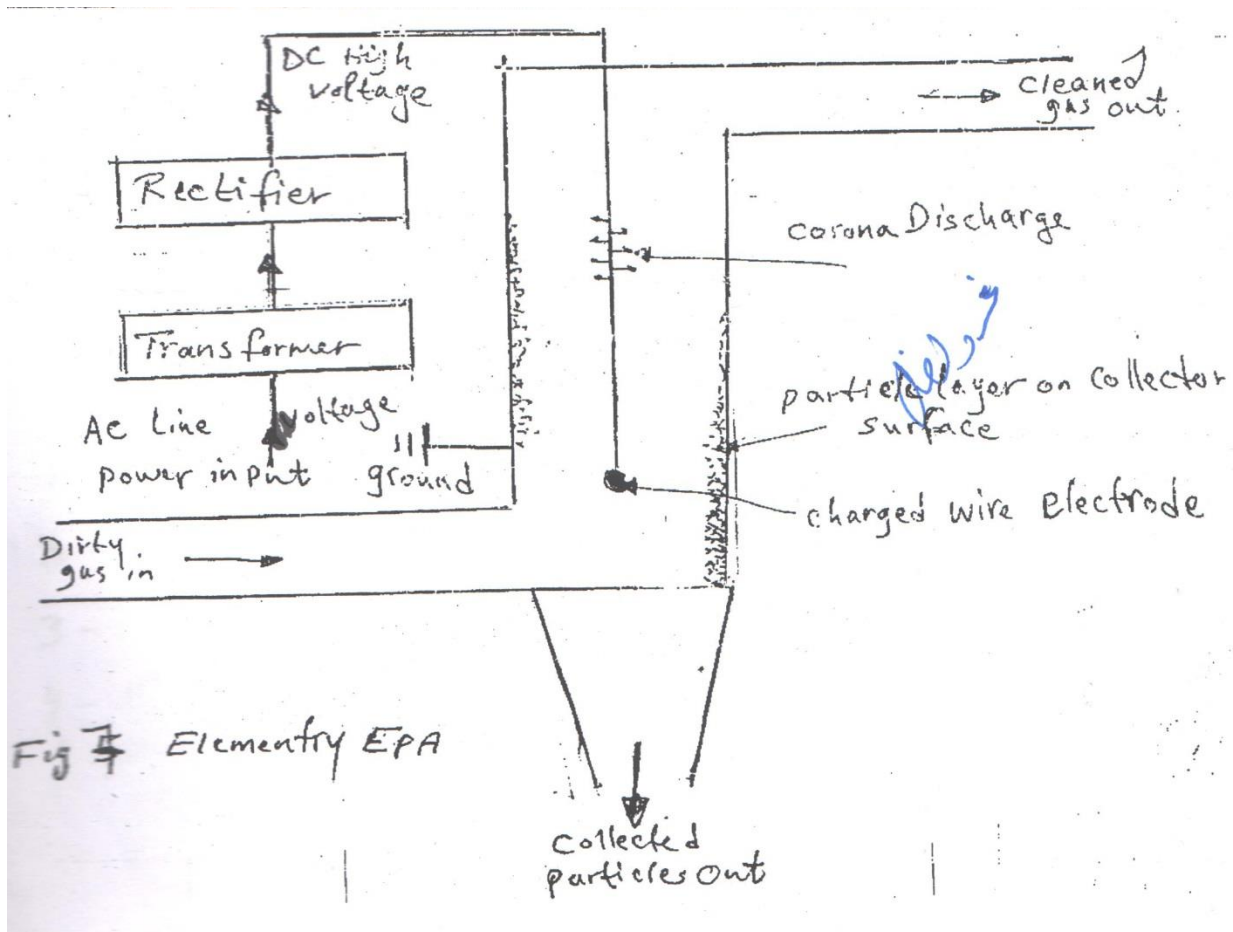

Water and waste water

Water is the most abundant chemical component with the biosphere. It's important to all life on earth including human life. The removal and dilution of most natural and human-made wastes are accomplished entirely by water

Sources of Water

The quality and quantity of water mainly are:-

- 1- **Groundwater.** is the water present beneath Earth's surface in soil pore spaces and in the fractures of rock formations. A unit of rock or an unconsolidated deposit is called an aquifer when it can yield a usable quantity of water. The depth at which soil pore spaces or fractures and voids in rock become completely saturated with water is called the water table. Groundwater is recharged from the surface; it may discharge from the surface naturally at springs and seeps, and can form oases or wetlands. Groundwater is also often withdrawn for agricultural, municipal, and industrial use by constructing and operating extraction wells. The study of the distribution and movement of groundwater is hydrogeology, also called groundwater hydrology
- 2- Surface water is water on the surface of continents such as in a river, lake, or wetland. It can be contrasted with groundwater and atmospheric water.
Non-saline surface water uses is replenished by precipitation and by recruitment from ground-water. It is lost through evaporation, seepage into the ground where it becomes ground-water, used by plants for transpiration, extracted by mankind for agriculture, living, industry etc. or discharged to the sea where it becomes saline
- 3- **Sea water:-** Seawater available in unlimited quantities can be converted into fresh water by a number of process. Conversion costs are two to five times higher treatments the fresh water.
Desalination is a term used for removal of dissolved salts from water.
- 4- **Reclaimed wastewater:-** is the water that has been treated sufficiently for direct reuse in industry and agriculture and for limited municipal applications

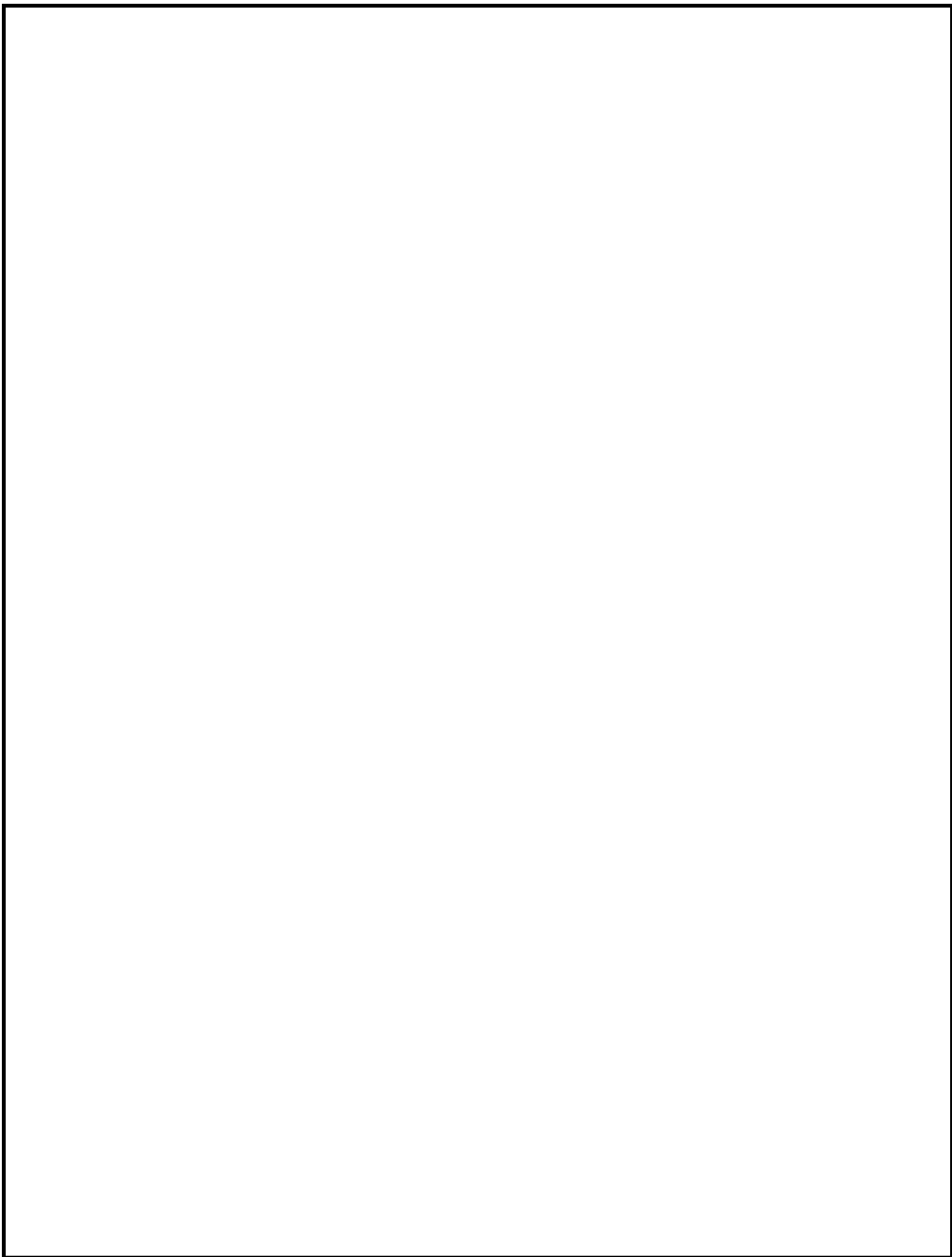

Seventh Lecture:

Utilizations of water

The most important uses are:-

- 1- Irrigation the amount of water required for irrigation purposes varies with climate of the region and the type of crops
- 2- Domestic water supply the requirements vary from season to season and from rural to urban areas.
- 3- Power generation cooling is the principle water use in thermal power generation and more than 99% of water used are required for consider cooling
- 4- Industrial water use industry is much depended on adequate water supply. The enormous demand the industry has for water is obvious such H₂SO₄ production, oil refinery, milk products....etc.

Water pollution

Water pollution is the pollution of bodies of water, such as lakes, rivers, seas, the oceans, as well as groundwater. It occurs when pollutants reach these bodies of water, without treatment. Waste from homes, factories and other buildings get into the water bodies and as a result water gets contaminated .

Water pollution is a problem for the species and ecosystems there. It affects plants and organisms living in the water. In almost all cases the effect is damaging not only to individual species and populations, but also to the wider biological communities. The color is usually green or brown but normal water can be blue.

Agriculture is one of the major sources of water pollution. The fertilizers given to the crops for better growth are washed into rivers and lakes, which in turn pollutes the water.

There are many chemicals that are naturally found in these bodies of water. Today water may be polluted by nitrates, phosphates, oil, acid rain, and debris such as sediment, fallen logs and so on. When people and animals drink water from such rivers, the poisonous chemicals may affect them. Life in rivers are also affected, and humans who consume fish may also have health problems

Origin of wastewater

Wastewater can be classified by their origin as domestic wastewater and industrial wastewater.

1- Domestic wastewater:-

that is collected then discharged from residential and commercial establishments.

2- Industrial wastewater is formed at industrial plants where water is used for various processes and also for washing and rinsing of equipment, room, etc.

Types of water pollutants and their effects

The main pollutants in water are:-

1- *Oxygen demanding wastes:-*

Dissolved oxygen :(Do) is essential for sustaining the plants and animal life in any aquatic system.

Biological Oxygen demand :(BOD) is a measure of oxygen used by micro-organism during the oxidation of organic material its most widely now measure for assessing the water pollution potential of a given organic waste.

2- *Disease causing Agents:*

Water is potential carrier of pathogenic micro-organism. These pathogens are carried into the water bodies by sewage and wastes from farms and various industries.

3- *Radioactive substances:*

The refining of uranium is the most important source of radioactive waste producing radium, bismuthetc.

Radioactive substances can enter humans with food and water and accumulated in blood, livers, muscles, tissues causing a serious health problem to human.

4- *Thermal discharge:*

Industry use large quantity for cooling purpose. This could result in increase in temperature of the water bodies and causes decreasing in the oxygen percentage

5- Oil:

is an important commodity and vital for every human activity now. Oil and oil wastes enter rivers and other water bodies from several sources like industrial effluent, oil refineries and storage tank.

Waste oil insoluble in water so it floats and spread rapidly into a thin layer. The lighter, low

molecular-weight elements, which are most toxic to organisms, evaporate and slow rate effect on life in the water.

6- *Mining activities:*

Mining is the process of crushing the rock and extracting coal and other minerals from underground. These elements when extracted in the raw form contain harmful chemicals and can increase the amount of toxic elements when mixed up with water which may result in health problems. Mining activities emit several metal waste and sulphides from the rocks and is harmful for the water.

7- *Marine dumping:*

The garbage produce by each household in the form of paper, aluminum, rubber, glass, plastic, food if collected and deposited into the sea in some countries. These items take from 2 weeks to 200 years to decompose. When such items enters the sea, they not only cause water pollution but also harm animals in the sea.

8- *Industrial waste:*

Industries produce huge amount of waste which contains toxic chemicals and pollutants which can cause air pollution and damage to us and our environment. They contain pollutants such as lead, mercury, sulphur, nitrates and many other harmful chemicals. Many industries do not have proper waste management system and drain the waste in the fresh water which goes into rivers, canals and later in to sea. The toxic chemicals have the capability to change the color of water, increase the amount of minerals, also known as Eutrophication, change the temperature of water and pose serious hazard to water organisms.

9- *Chemical fertilizers and pesticides:*

Chemical fertilizers and pesticides are used by farmers to protect crops from insects and bacteria's. They are useful for the plants growth. However, when these chemicals are mixed up with water, produce harmful for plants and animals. Also, when it rains, the chemicals mixes up with rainwater and flow down into rivers and canals which pose serious damages for aquatic animals.

10- *Animal waste*

The waste produced by animals is washed away into the rivers when it rains. It gets mixed up with other harmful chemicals and causes various water-borne diseases like cholera, diarrhea, jaundice, dysentery and typhoid.

11. Urban development

As the population has grown, so has the demand for housing, food, and cloth. As more cities and towns are developed, they have resulted in increasing use of fertilizers to produce more food, soil erosion due to deforestation, increase in construction activities, inadequate sewer collection, and treatment, landfills as more garbage is produced, increase in chemicals from industries to produce more materials.

12 - The burning of fossil fuels

Fossil fuels like coal and oil when burnt produce a substantial amount of ash in the atmosphere. The particles which contain toxic chemicals when mixed with water vapor result in acid rain. Also, carbon dioxide is released from the burning of fossil fuels which result in global warming.

Eighth Lecture:

Water treatment

Water treatment is process that makes water more acceptable for a specific end-use. The end use may be drinking, industrial water supply, irrigation ...

Water treatment by reverse osmosis

in our time the method of reverse osmosis is the main way for water treatment, this way consist of three steps:

First level. Primary treatment (physical and chemical)

physical treatment

The water from sea, rivers and wells transporting by pumps to the tanks, Then the water transfer to the multimedia filters using low-pressure pump.

Pumps push the water through the multimedia filters sand, stone and grave which prevent the suspended particles from passage .

Then it moves to the activated carbon filter to remove of chlorine, by adsorption which causes damage to membranes in the reverse osmosis system , the carbon filter capable of removing some of organic material and smell too.

Then the water moves to the softener unit to reduce the turbidity by removing some salts, especially magnesium and calcium salts, to prevent them from precipitating on the membranes.

The final stage of physical treatment is the passing water through a filter 5 mic to remove impurities that have passed through the multiple filter

* Must putting pressure gauges on the filters to see if the filters are clogged

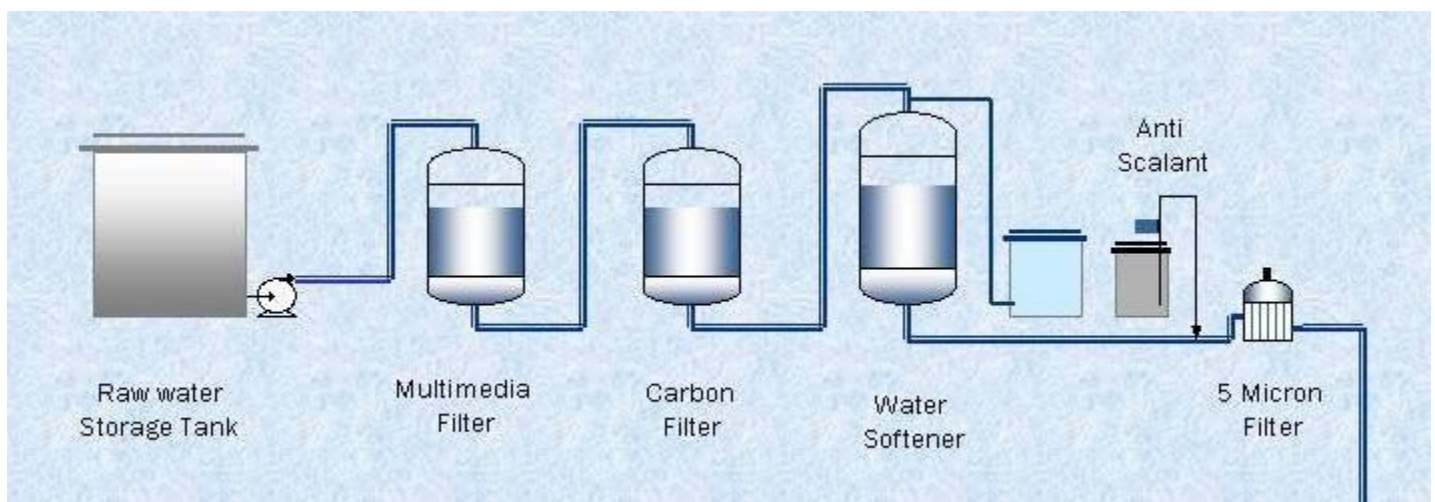

Second level. (The reverse osmosis)

Osmosis: A naturally occurring phenomenon and one of the most important processes in nature. A solution that is less concentrated will have a natural tendency to migrate to a solution with a higher concentration, Osmosis occurs without energy or pressure.

A semi permeable membrane: is a membrane that will allow some atoms or materials to pass but not others.

A reverse osmosis membrane: is a semi –permeable membrane that allows the passage of water but not majority of dissolved salts, organics, bacteria.

*What will reverse osmosis remove from water?

Reverse osmosis is capable of removing up to 99 % of the dissolved salts , particles, organics, bacteria from the feed water .(except viruses) .

* An RO membrane rejects contaminants based on their size and charge.

Example Na^+ , Ca^{++} , gases) RO membrane in Ca^{++} more effect than Na^+ because the charge in Ca^{++} and non-effective with gases because the gas size (very small).

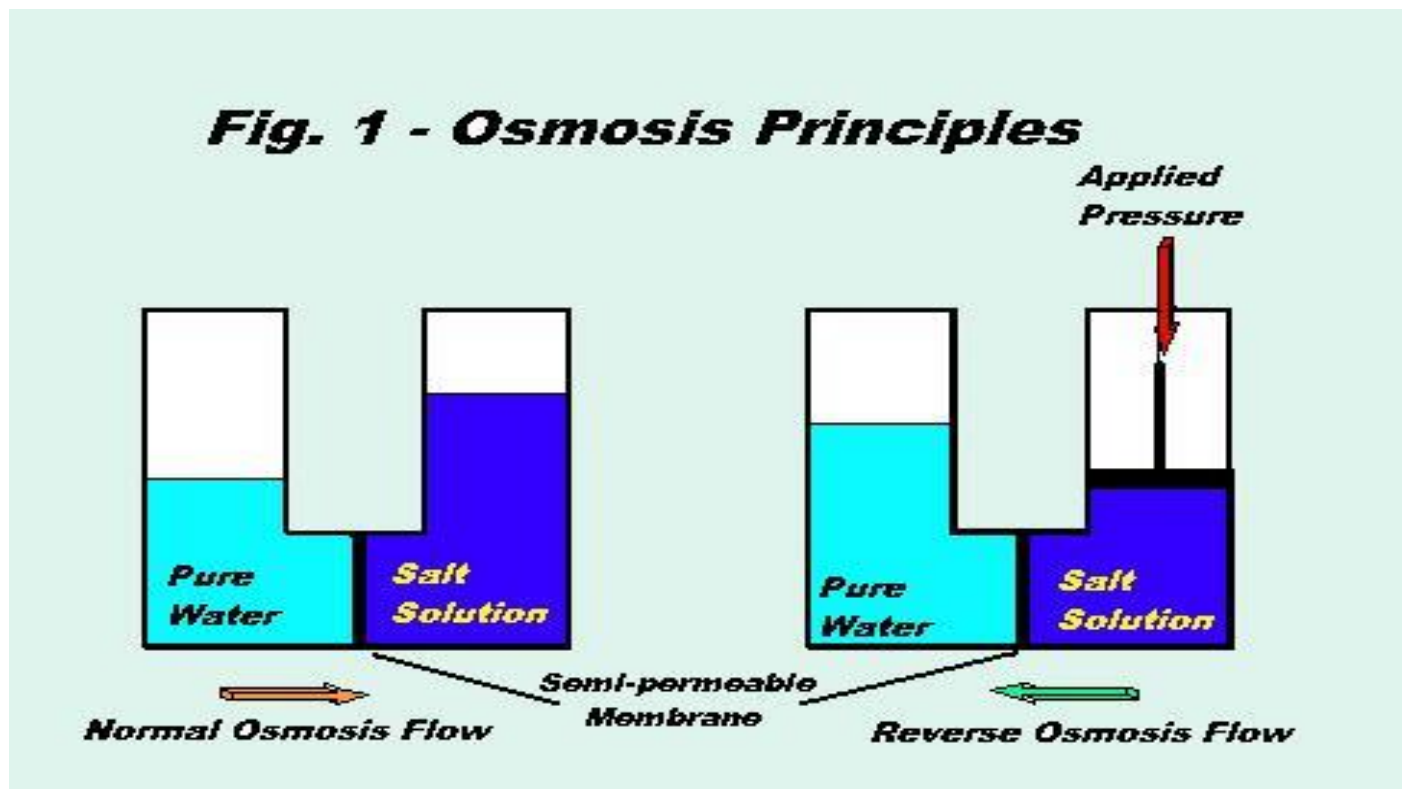

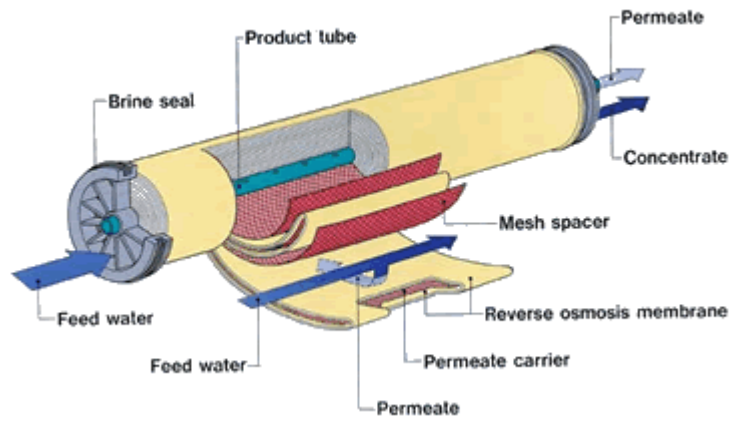

RO types stage

1 Stage RO System

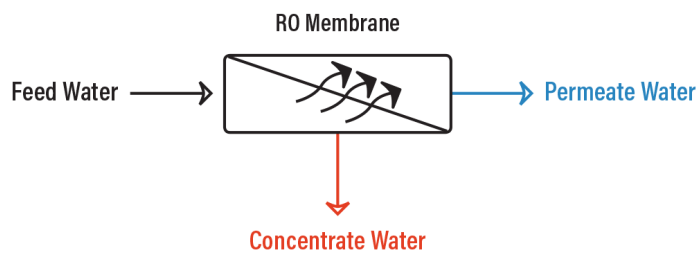

2 Stage RO System

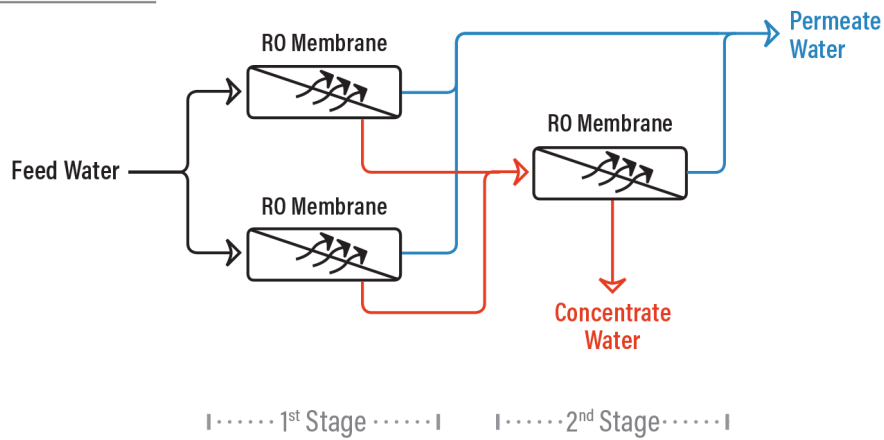

RO performance calculation...

1 – Salt rejection % .

The function tells you how effective the RO membranes are removing contaminants.

Salt rejection % = $\frac{\text{TDS of feed water} - \text{TDS of permeate water}}{\text{TDS of feed water}}$

The well design of RO system properly functioning RO membranes will reject 95% to 99 % of most feed water contaminants .

The higher percentage of salt rejection mean the RO system very effective but the low percentage mean the membranes need cleaning or replacement.

2 – Salt passage % .

This is the amount of salts expressed as a percentage that are passing through the RO system.

Salt passage = $1 - \text{salt rejection}$.

The lower percentage of passage salts means the RO system effective.

3 – Recovery %.

Percent recovery is the amount of water that is being (recovered) as good permeate water.

Recovery % = $\left(\frac{\text{permeate flow rate}}{\text{feed flow rate}}\right) * 100\%$

Industrial RO system typically run anywhere from 50% to 85 % recovery.

Third level (finally treatment)

It handles the output of the reverse osmosis by UV unit to kill the bacteria

Then stored and pumped for consumption .

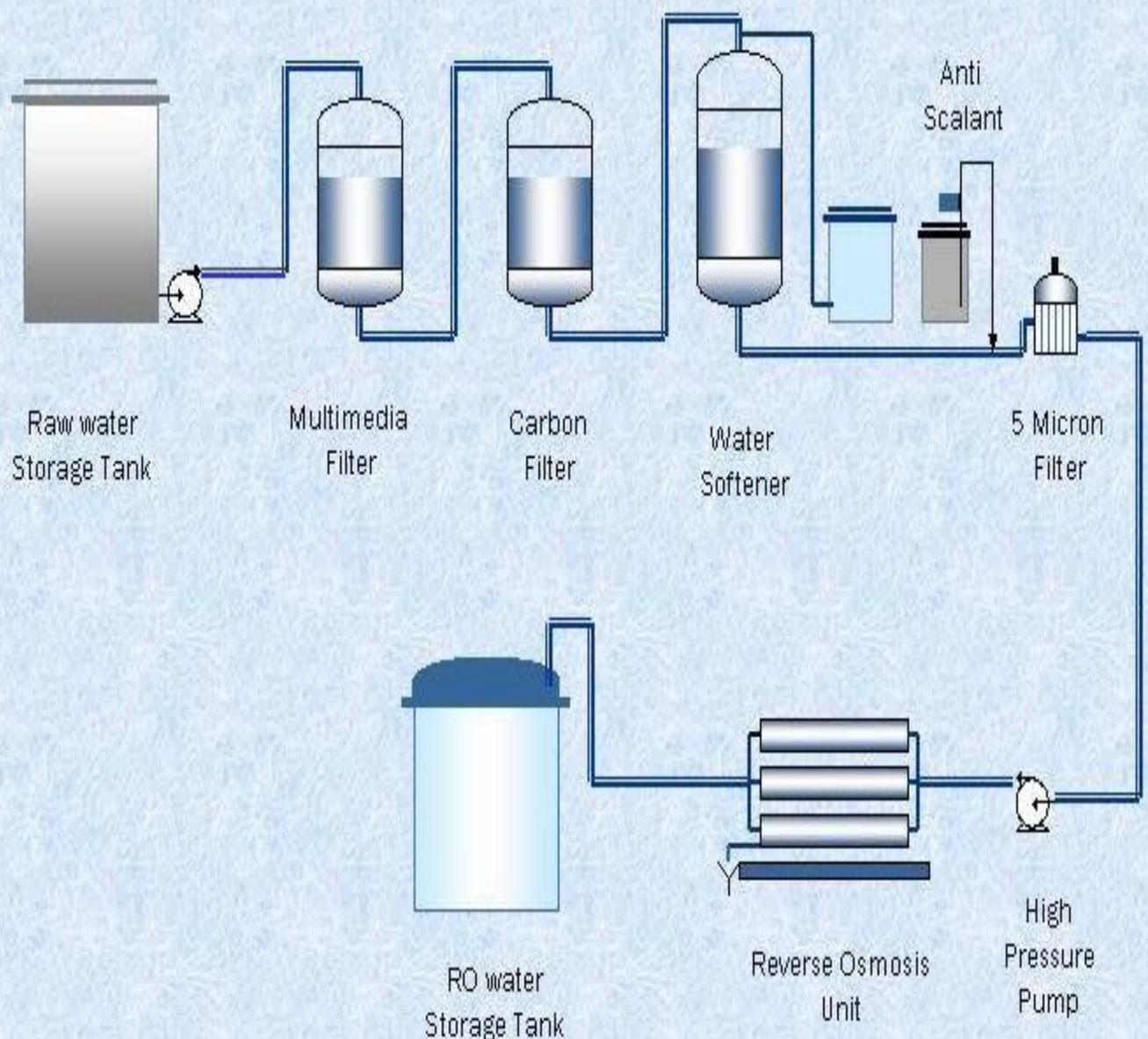

Raw water
Storage Tank

Multimedia
Filter

Carbon
Filter

Water
Softener

Anti
Scalant

5 Micron
Filter

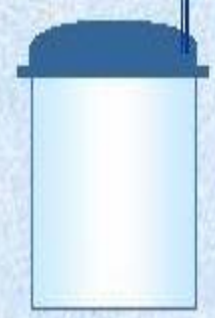

RO water
Storage Tank

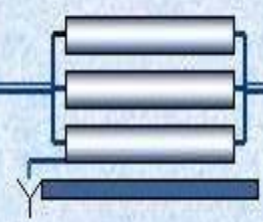

Reverse Osmosis
Unit



High
Pressure
Pump

Water treatment by UV

Radiation starts photochemical reaction leading to the destruction of genetic information contained in DNA. Where bacteria lose their ability to proliferate and become corrupted. Even parasites such as Giardia or Cryptosporidia, violently resistance to chemical disinfectants, less effectively as a result of this radiation .You can also use ultraviolet light to remove chlorine and chloramines types of water, where this process is called photosynthesis analysis and requires a higher than normal dose of cleansing. The microorganisms sterile not be removed from the water.

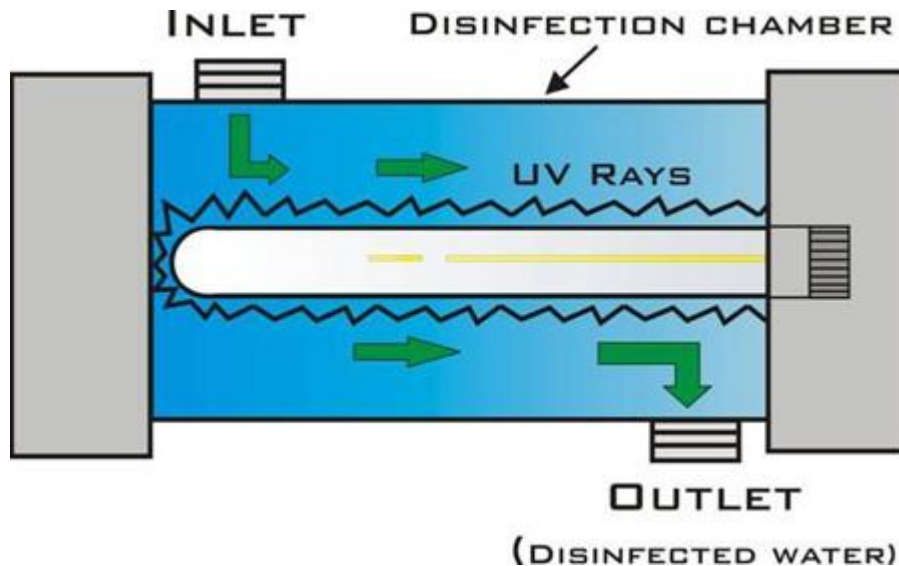

Water treatment by ozone

Ozone is a consisting of three atoms of oxygen O_3 . It is formed in the upper layer of the atmosphere because of the light weight, ozone absorbs ultraviolet radiation in the upper layer of the atmosphere and this is protects us from harmful solar radiation .

Ozone is produced in practically by ultraviolet (UV) or by air to pass the High Voltage Discharge .

Ozone strong oxidizing substance which decomposes ozone and emancipated oxygen atom O which has a very high antioxidant capacity of attach themselves where pollutants and become clean and pure, so the ozone sterilization is the most effective material.

Ozone remains effective in water for long periods and thus maintains the sterile water for long periods in tanks and extensions in drinking water bottles

Ninth Lecture

Renewable energy

is energy that is collected from renewable resources, which are naturally replenished on a human timescale,

such as sunlight, wind, rain, tides, waves, and geothermal heat. Renewable energy often provides energy in four important areas: electricity generation, air and water heating/cooling, transportation, and rural energy services

Renewable Energy Source

Every day we rely on energy to provide us with electricity, hot water, and fuel for our cars. Most of this energy comes from fossil fuels, such as coal, oil, and natural gas. These are nonrenewable energy sources, which means that if we use them all up, we can never get more during our lifetime. Fossil fuels also contribute greatly to global climate change by releasing carbon dioxide into the air when they are burned.

Because fossil fuels can run out and are bad for the environment, it is important that we start switching to other energy sources, like renewable energy sources. These are energy sources that are constantly being replenished, such as sunlight, wind, and water. This means that we can use them as much as we want, and we do not have to worry about them running out. Additionally, renewable energy sources are usually much more environmentally friendly than fossil fuels. Overall, they release very few chemicals, like carbon dioxide, that can harm the environment.

Currently, less than ten percent of all the energy we use comes from renewable sources. So, you might be wondering, 'if renewable energy sources do not harm the environment and will not run out, then why are we not using them everywhere and all the time?' It is because many of them are currently expensive to harness, are inefficient, or have other disadvantages. For example, using energy from the wind might be great in an area that is really windy all year-round, but it wouldn't work so well in an area with very little wind.

Advantages of renewable energy

Using renewable energy over fossil fuels has a number of advantages. Here are some of the top benefits of going green:

1. Renewable energy won't run out

Renewable energy technologies use resources straight from the environment to generate power. These energy sources include sunshine, wind, tides, and biomass, to name some of the more popular options. Renewable resources won't run out, which cannot be said for many types of fossil fuels – as we use fossil fuel resources, they will be increasingly difficult to obtain, likely driving up both the cost and environmental impact of extraction.

2. Maintenance requirements are lower

In most cases, renewable energy technologies require less overall maintenance than generators that use traditional fuel sources. This is because generating technology like solar panels and wind turbines either have few or no moving parts and don't rely on flammable, combustible fuel sources to operate. Fewer maintenance requirements translate to more time and money saved.

3. Renewables save money

Using renewable energy can help you save money long term. Not only will you save on maintenance costs, but on operating costs as well. When you're using a technology that generates power from the sun, wind, steam, or natural processes, you don't have to pay to refuel. The amount of money you will save using renewable energy can vary depending on a number of factors, including the technology itself. In most cases, transitioning to renewable energy means anywhere from hundreds to thousands of dollars in savings.

4. Renewable energy has numerous health and environmental benefits

Renewable energy generation sources emit little to no greenhouse gases or pollutants into the air. This means a smaller carbon footprint and an overall positive impact on the natural environment. During the combustion process, fossil fuels emit high amounts of greenhouse gases, which have been proven to exacerbate the rise of global temperatures and frequency of extreme weather events.

The use of fossil fuels not only emits greenhouse gases but other harmful pollutants as well that lead to respiratory and cardiac health issues. With renewable energy, you're helping decrease the prevalence of these pollutants and contributing to an overall healthier atmosphere.

5. Renewables lower reliance on foreign energy sources

With renewable energy technologies, you can produce energy locally. The more renewable energy you're using for your power needs, the less you'll rely on imported energy

Disadvantages of renewable energy

Renewable energy has many benefits, but it's not always sunny when it comes to renewable energy. Here are some disadvantages to using renewables over traditional fuel sources.

1. Higher upfront cost

While you can save money by using renewable energy, the technologies are typically more expensive upfront than traditional energy generators. To combat this, there are often financial incentives, such as tax credits and rebates, available to help alleviate your initial costs of renewable technology.

2. Intermittency

Though renewable energy resources are available around the world, many of these resources aren't available 24/7, year-round. Some days may be windier than others, the sun doesn't shine at night, and droughts may occur for periods of time. There can be unpredictable weather events that disrupt these technologies. Fossil fuels are not intermittent and can be turned on or off at any given time.

3. Storage capabilities

Because of the intermittency of some renewable energy sources, there's a high need for energy storage. While there are storage technologies available today, they can be expensive, especially for large-scale renewable energy plants. It's worth noting that energy storage capacity is growing as the technology progresses, and batteries are becoming more affordable as time goes on.

4. Geographic limitations

there are some geographies that are more suitable for renewable technologies than others.

Tenth Lecture

Types of renewable energy

Hydroelectricity

is electricity made by generators that are pushed by movement of water. It is usually made with dams that block a river to make a reservoir or collect water that is pumped there. When the water is released, the pressure behind the dam forces the water down pipes that lead to a turbine. This causes the turbine to turn, which turns a generator which makes electricity.

This renewable energy method makes about one sixth of the world's electricity. It produces less pollution than the fires of steam engines do.

Advantages of hydroelectricity

The way the electricity is produced does not harm the environment as much as fossil fuels like oil or coal do. Hydroelectricity is very powerful and safe, and produces no waste.

An important advantage of hydroelectric dams is their ability to be used as a peaking power plant. When the electricity demand declines, the dam simply stores more water. Water that has been stored in a reservoir can be released (let go) when needed, so the energy can be made quickly. Some hydroelectricity generators use pumped storage to store excess energy (often during the night), by using the electricity to pump water up into a basin. Electricity can be generated when demand increases. This flexibility also makes hydroelectricity a good match for less controllable intermittent energy sources. When the wind is not blowing or the sun is not shining, hydroelectricity can be created.

In practice the utilization of stored water in river dams is sometimes complicated by demands for irrigation which may occur out of phase with peak electrical demands.

Another advantage is that hydroelectricity cannot run out as long as there is a good water supply. Once the dam is built, the electricity costs very little, no waste or pollution is produced, and electricity can be generated whenever it is needed.

A few hydro turbines do not have a dam but instead use the current of the "run of the river". They produce less electricity and cannot store energy for later use.

Disadvantages of hydroelectricity

The building of large dams to hold water can damage the environment. In 1983, the Australian government stopped the Tasmanian state government from building a dam on the Gordon River in Tasmania after a huge public protest. The dam would have flooded the Franklin River. The Three Gorges Dam in China is the world's largest hydroelectricity project, and the world's largest power plant of any kind. The dam has flooded a huge area, meaning that 1.2 million people had to be moved

Scientists are concerned about many problems with the dam, such as pollution, silt, and the danger of the dam wall breaking

Solar energy

is the radiant light and heat from the sun that has been harnessed by humans since ancient times using a range of ever-evolving technologies. Solar radiation along with secondary solar resources account for most of the available renewable energy on earth.

However, only a minuscule fraction of the available solar energy can be used to:

- Generate Electricity
- Heating and Cooling
- Cooking
- Water Desalination

Solar Resource Potential

Solar irradiation data is needed at all levels of solar power development, from initial government planning through to large-scale project development or the calculations needed to size smaller systems. In the past such data was provided at a relatively coarse level from NASA and other global providers, but more recently specialist models have been developed to more precisely calculate global horizontal irradiation (GHI) and direct normal irradiation (DNI) using primarily cloud cover data from satellites. A number of firms now offer such data as a commercial service. Based on this, it is possible to calculate average annual power output from a theoretical photovoltaic power plant (PVOUT), taking into account temperature, tilt, and the efficiency of the equipment being used (solar panels and balance of system components).

Solar resource data, including GHI, DNI and PVOUT is now available globally, for free, via the Global Solar Atlas, which is provided by the World Bank Group. The same website has downloadable global, regional and country maps available in high resolution.

Solar Technologies and Techniques

Solar energy technologies refer primarily to the use of solar radiation for practical ends. All other renewable energies other than geothermal derive their energy from energy received from the sun.

Solar technologies are broadly characterized as either passive solar or active solar depending on the way they capture, convert and distribute sunlight. Active solar techniques include the use of photovoltaic

modules (also called photovoltaic panels) and solar thermal collectors (with electrical or mechanical equipment) to convert sunlight into useful outputs. Passive solar techniques include orienting a building to the Sun, selecting materials with favorable thermal mass or light dispersing properties, and designing spaces that naturally circulate air.

Active solar technologies increase the supply of energy and are considered supply side technologies, while passive solar technologies reduce the need for alternate resources and are generally considered demand side technologies.

Solar Thermal Technologies

Solar thermal technologies are harnessing solar energy for thermal energy (heat). Solar thermal technologies comprise flat collectors for low- and medium temperatures and high temperature collectors concentrating sunlight using mirrors and lenses.

There are even solar thermal system for cooling purposes that work with adsorption, absorption or desiccant cooling^[2].

through the difference between the sea-surface temperatures and under 300m depth, which can be harnessed for extracting work through a Rankine cycle.